

BNSF Br. 196.6 Replacement Design Concepts Considered

November 6, 2019

Purpose of Project: Condition-Based Bridge Replacement

Replacement bridge needs to include...

1. Piers can accept a future second track.
2. Minimal impacts on environment and public.
3. Optimal cost, schedule and efficiency.

Piers accept a future second track - Why?

BNSF Approach to Bridge Construction: Where we can potentially foresee the need for future added capacity, we construct piers to accommodate an added track.

Reason: Minimizes the impacts on the environment and public by constructing one pier for two tracks, instead of constructing a second pier in the future.

Design Concepts Considered

1. 200ft Spans – Piers 92.5ft upstream
2. 400ft Spans – Piers 92.5ft upstream
3. 200ft Spans – Piers 42.5ft upstream
4. 200ft Spans - Piers 20ft upstream (BNSF Preferred Design)

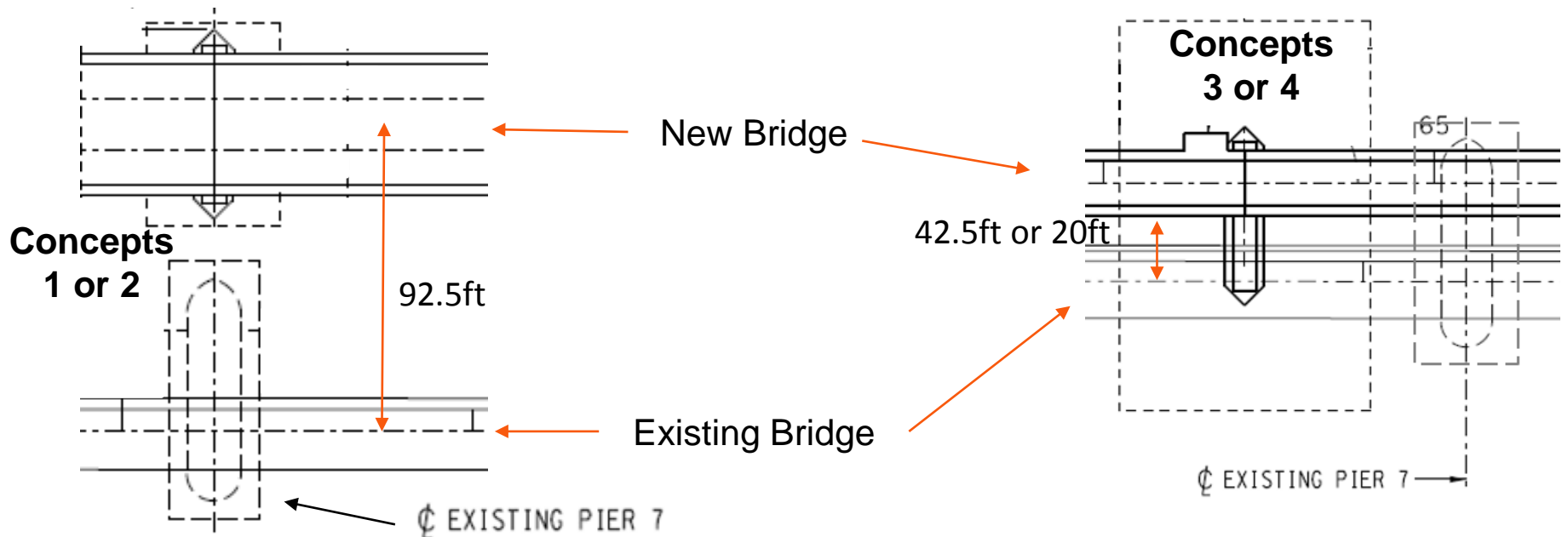

Why not closer than 92.5ft?

Ice breaker on north side of pier

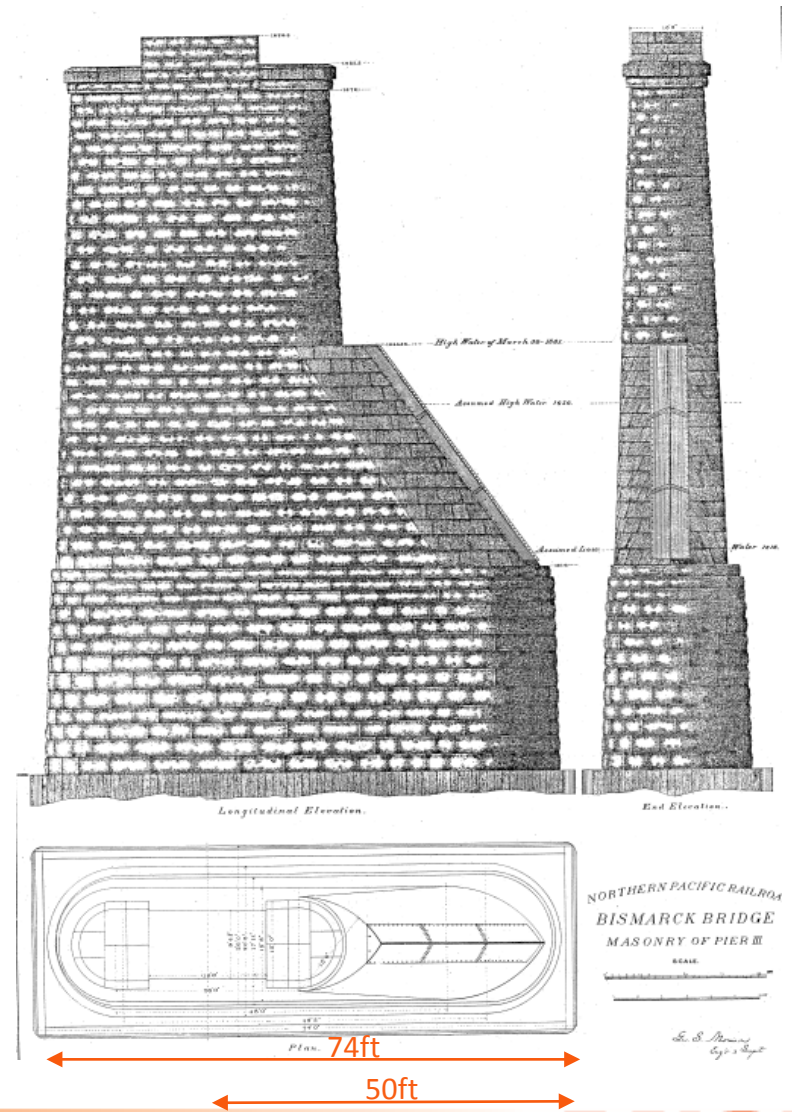

Why not closer than 92.5ft?

NOTE: Approx. 10ft between new and existing pier

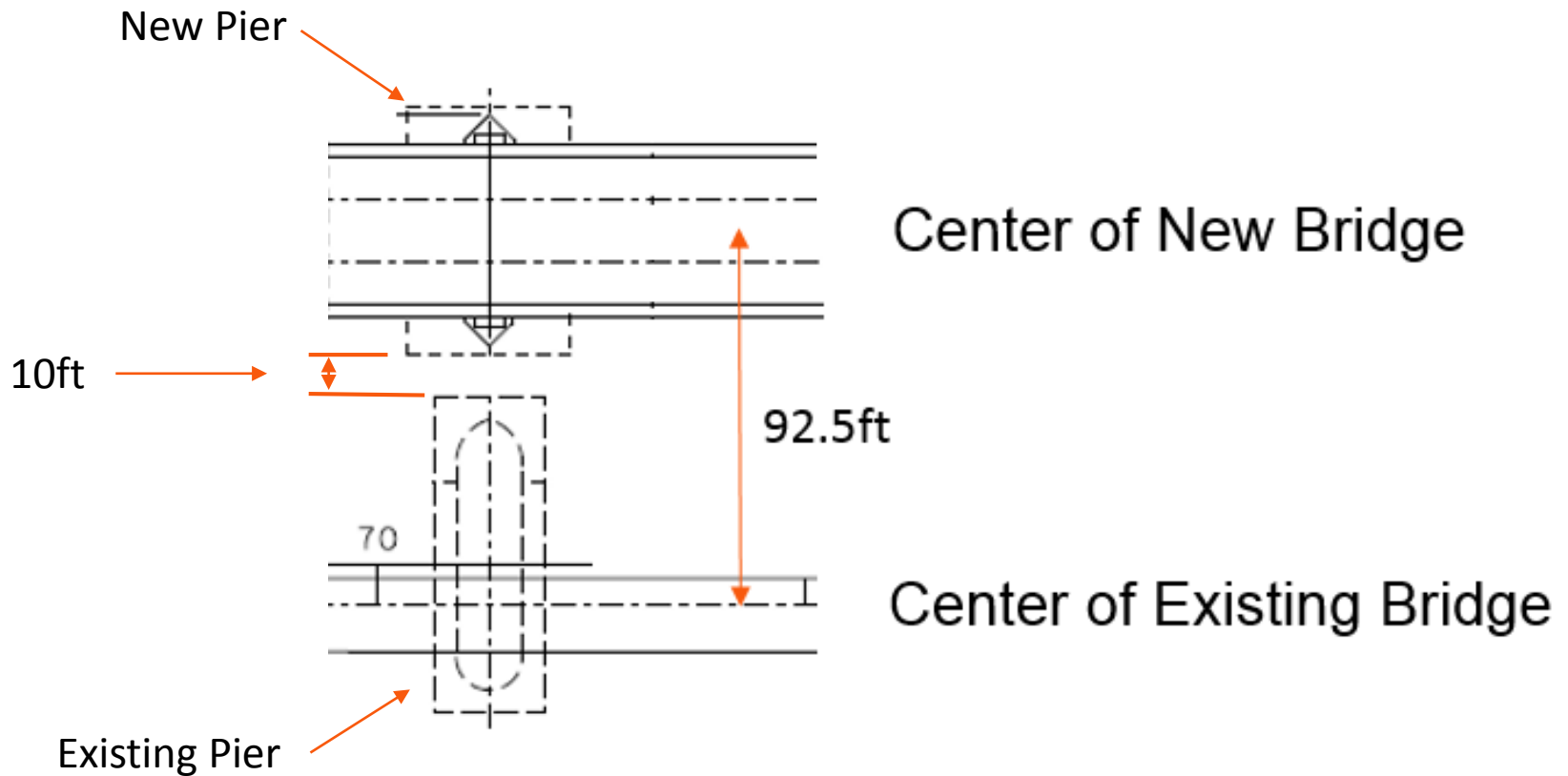

Concept 1:

200ft Spans, Piers 92.5ft Upstream

Concept 1: 200ft Spans, Piers 92.5ft Upstream



Concept 1: 200ft Spans, Piers 92.5ft Upstream

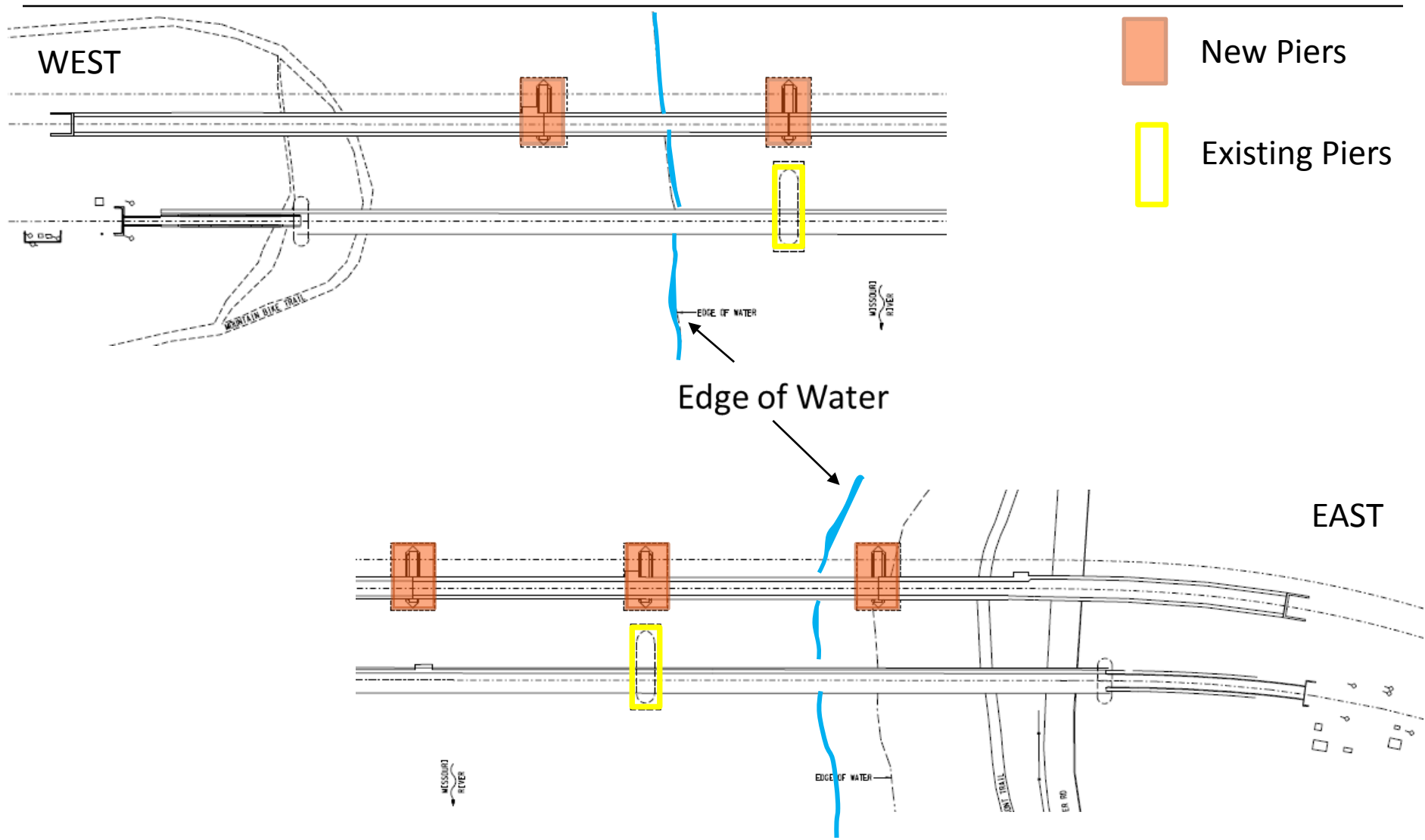

Concept 1: 200ft Spans, Piers 92.5ft Upstream

1. Environmental Impacts

1. Keeping the existing bridge, creates a rise in water elevation.
2. Remove the existing bridge, yields a no-rise in water elevation.

2. Impacts on Public

1. Construction limits extend beyond RW line.
2. Encroach on Bismarck water supply reservoirs.
3. Track geometry drives need to replace rail bridge over I-194.

3. Cost and Schedule

1. Increase in cost and duration of schedule; approx. \$25M-\$30M and add two to three years.

4. Efficiency

1. Able to construct piers to accept two tracks. One track now and a future second track.

Concept 1: 200ft Spans, Piers 92.5ft upstream

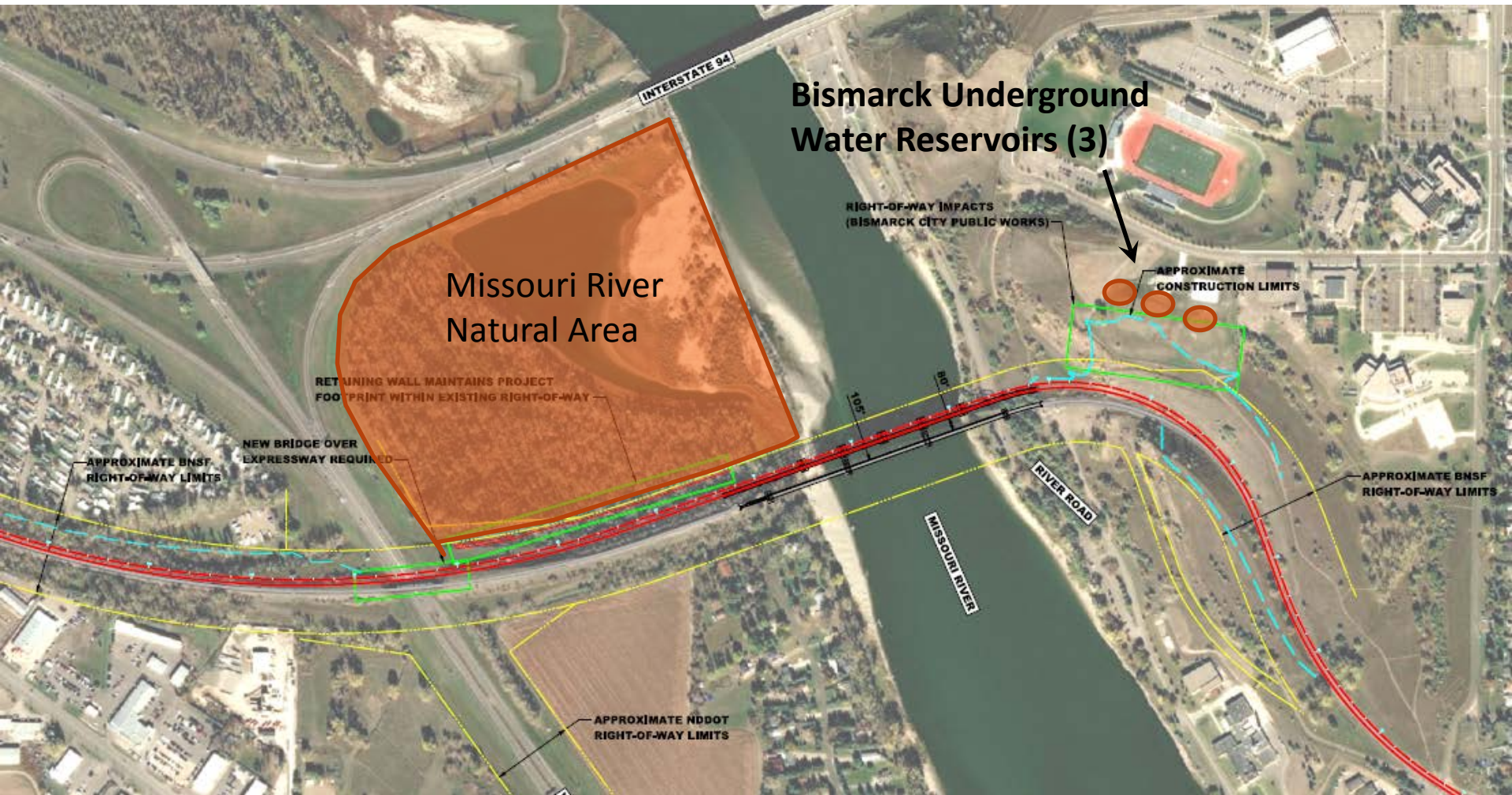

East End – Bismarck Water Reservoirs

Impacts where the construction limits encroach on the City of Bismarck Underground Water Reservoirs:

- 1. Acquire R/W from the City of Bismarck.**
- 2. Concerns about impacts to piping, underground tanks, slope stability, etc. for Bismarck UG reservoirs.**

East End – Bismarck Water Reservoir

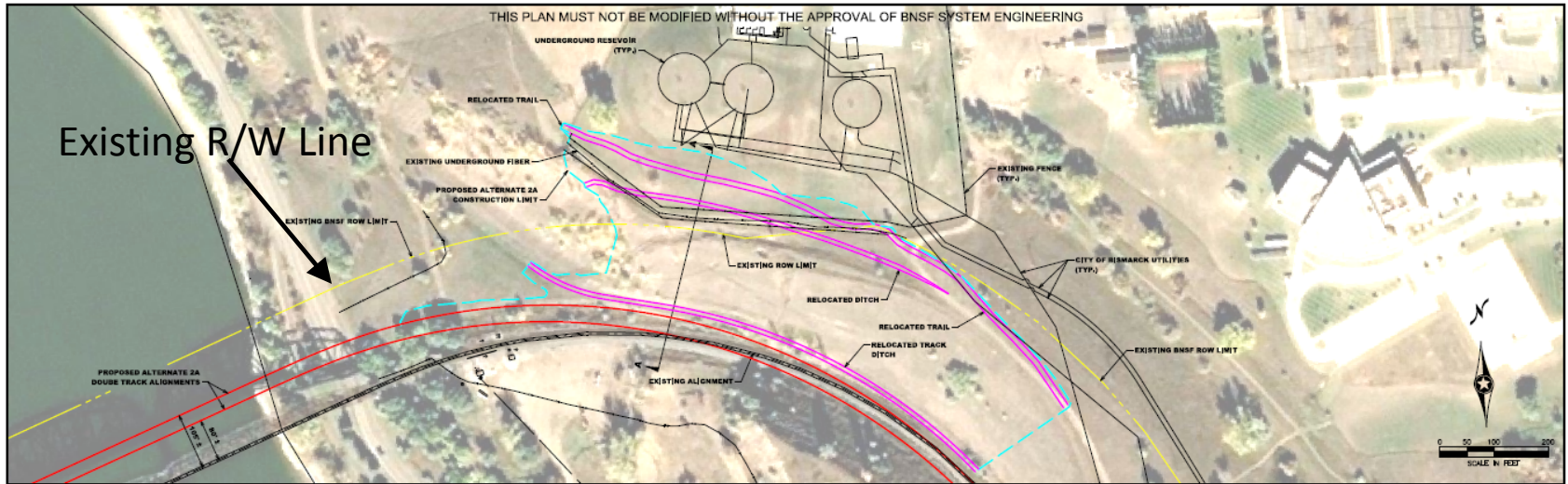

Encroachment on Reservoirs

Moving the new bridge further north requires a significant amount of excavation into the slope supporting Bismarck water reservoirs. The original excavation for the track is the primary culprit of the chronic movement of the pier nearest River Road.

Existing R/W Line

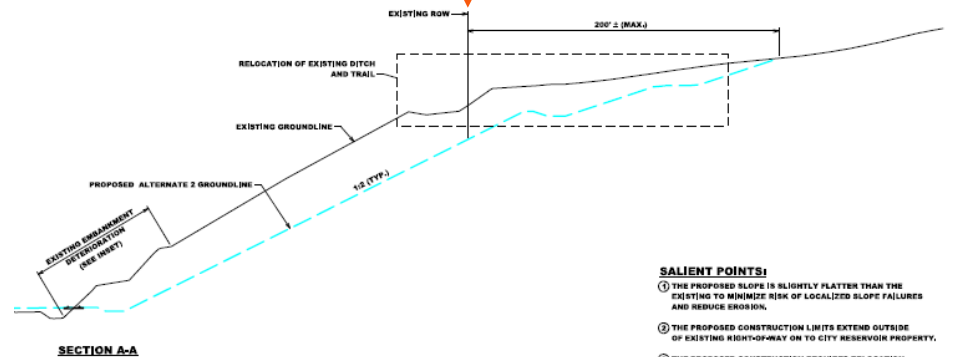

SALIENT POINTS:

- ① THE PROPOSED SLOPE IS SLIGHTLY FLATTER THAN THE EXISTING TO MINIMIZE RISK OF LOCALIZED SLOPE FAILURES AND REDUCE EROSION.
- ② THE PROPOSED CONSTRUCTION LIMITS EXTEND OUTSIDE OF EXISTING RIGHT-OF-WAY ON TO CITY RESERVOIR PROPERTY.
- ③ THE PROPOSED CONSTRUCTION REQUIRES RELOCATION OF THE EXISTING DITCH AND TRAIL LOCATED AT THE TOP OF THE SLOPE, RELOCATION OF THE DITCH AND SLOPE FURTHER EXTENDS CONSTRUCTION LIMITS OFF OF RIGHT-OF-WAY.

NO.	DATE	BY	DESCRIPTION OF REVISIONS

 444 Cedar Street, Suite 1550 508 P.O. Box 55101 58105-0510 Bismarck, ND	DATE:	08/11/2019	DATE:	08/11/2019
	REVISION:	01	DATE:	08/11/2019
VERIFY SCALE:	BASED ONE INCH ON ORIGINAL DRAWING IF NOT ONE INCH ON THIS DRAWING ADJUST SCALES ACCORDINGLY			



BNSF RAILWAY COMPANY
BRIDGE NO 196.6A GRADING PLAN
BISMARCK, ND (MP 196.38 - MP 197.20)

ALTERNATE 2A
DOUBLE TRACK EAST
EMBANKMENT GRADING

CONTRACT NO.	08055-000
DRAWING NO.	



West End – Missouri River Natural Area

Impacts:

1. **Stay in BNSF R/W - Construct the 35ft+/- tall retaining wall. Added cost of \$20M.**
2. **Extend off BNSF R/W – Acquire 80ft strip of property from Missouri River Nature Preserve to construct earth embankment. North Dakota DOT advised this land was purchased with federal funds during the construction of the interstate under the authority of 23 CFR 752.9 Scenic Lands and is protected by Section 4(f). It appears there is not a path forward to acquire this property.**

West End – Missouri River Natural Area

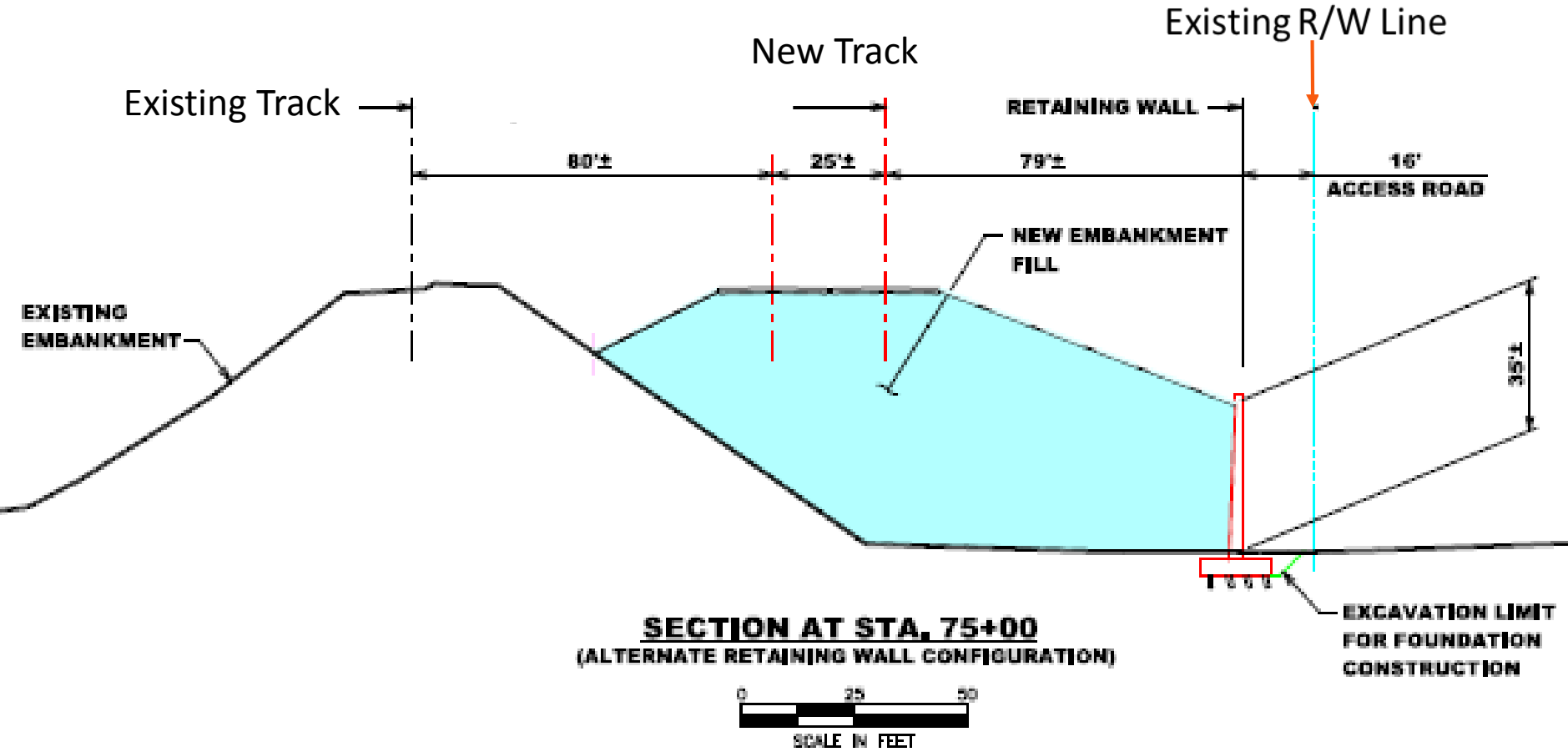

West End – Missouri River Natural Area

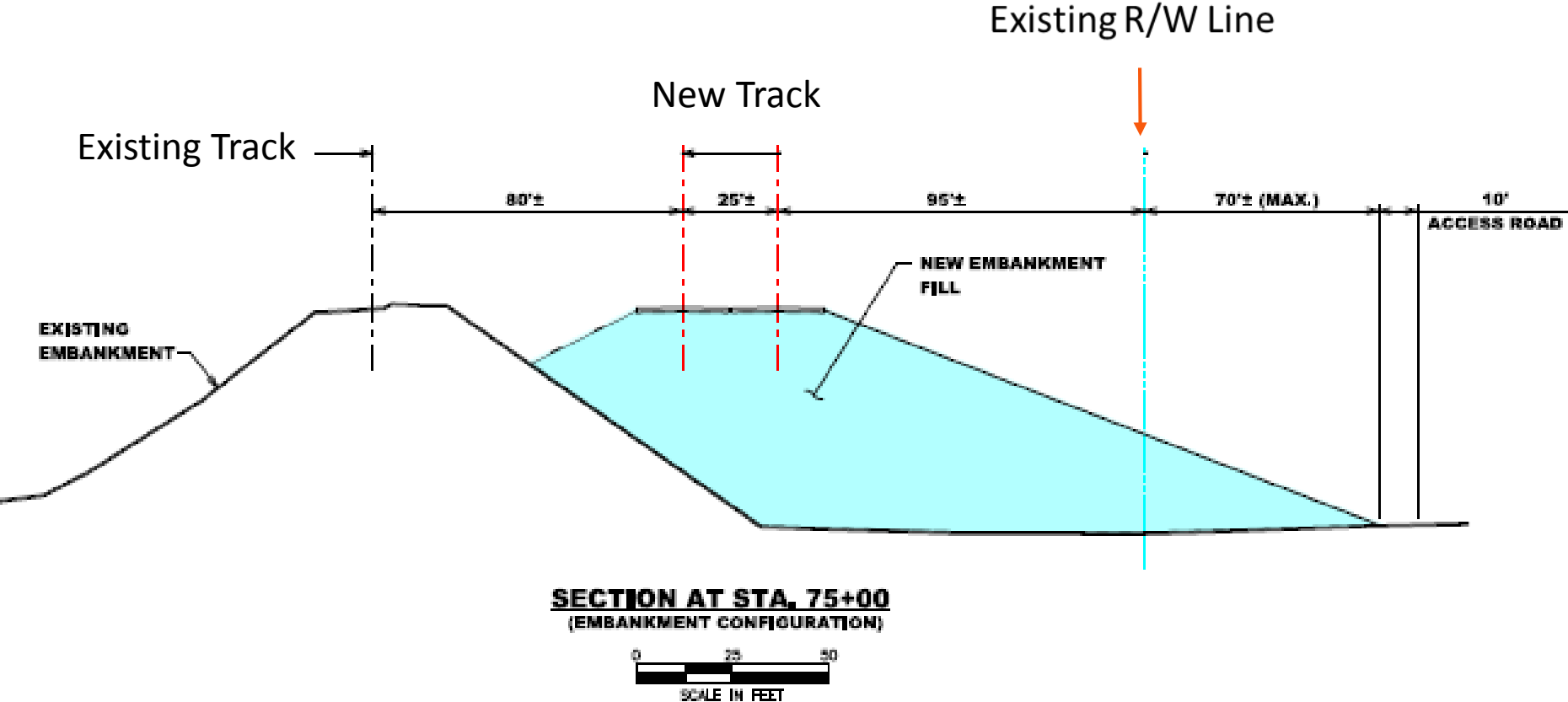

Concept 2:

400ft Spans, Piers 92.5ft Upstream

Concept 2: 400ft Spans, Piers 92.5ft Upstream



Concept 2: 400ft Spans, Piers 92.5ft Upstream

WEST

-  New Piers
-  Existing Piers

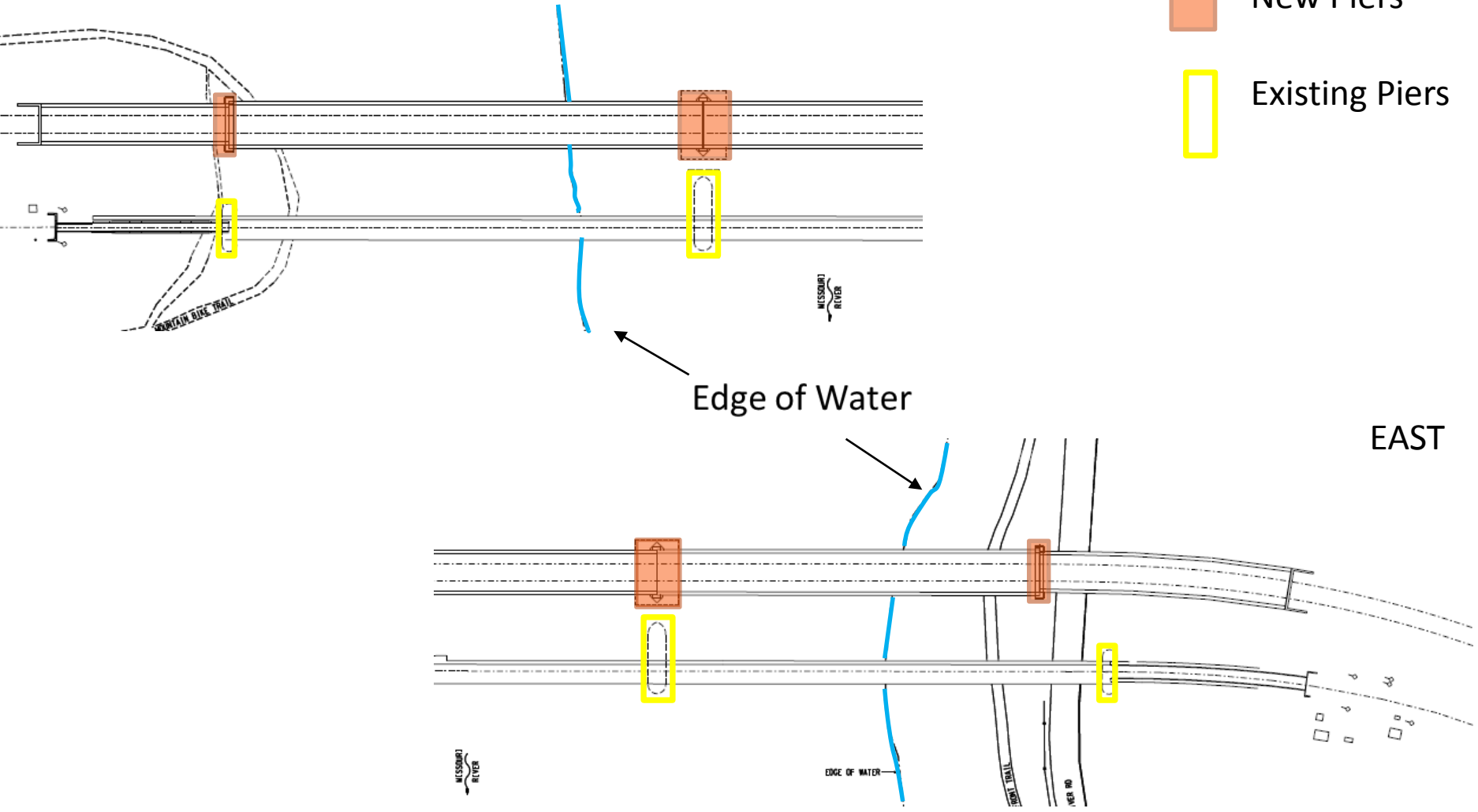

EAST



Concept 2: 400ft Spans, Piers 92.5ft Upstream

1. Environmental Impacts

1. Due to depth and width of the river, at least two of the three truss spans will require a significant amount of falsework in the river. While this is a temporary impact, it poses a much greater risk to cause flooding.

2. Impacts on Public

1. Construction limits extend even further beyond RW line.
2. Additional encroachment on Bismarck water supply reservoirs.
3. Track geometry drives need to replace rail bridge over I-194.

3. Cost and Schedule

1. Increase in cost and duration of schedule; approx. \$70M-\$75M and add two to four years.

4. Efficiency Reduction

1. Erect a double-track truss now, before a second track is needed OR construct larger piers to accommodate two single-track truss, one for each track.

Concept 2: 400ft Spans, Piers 92.5ft upstream

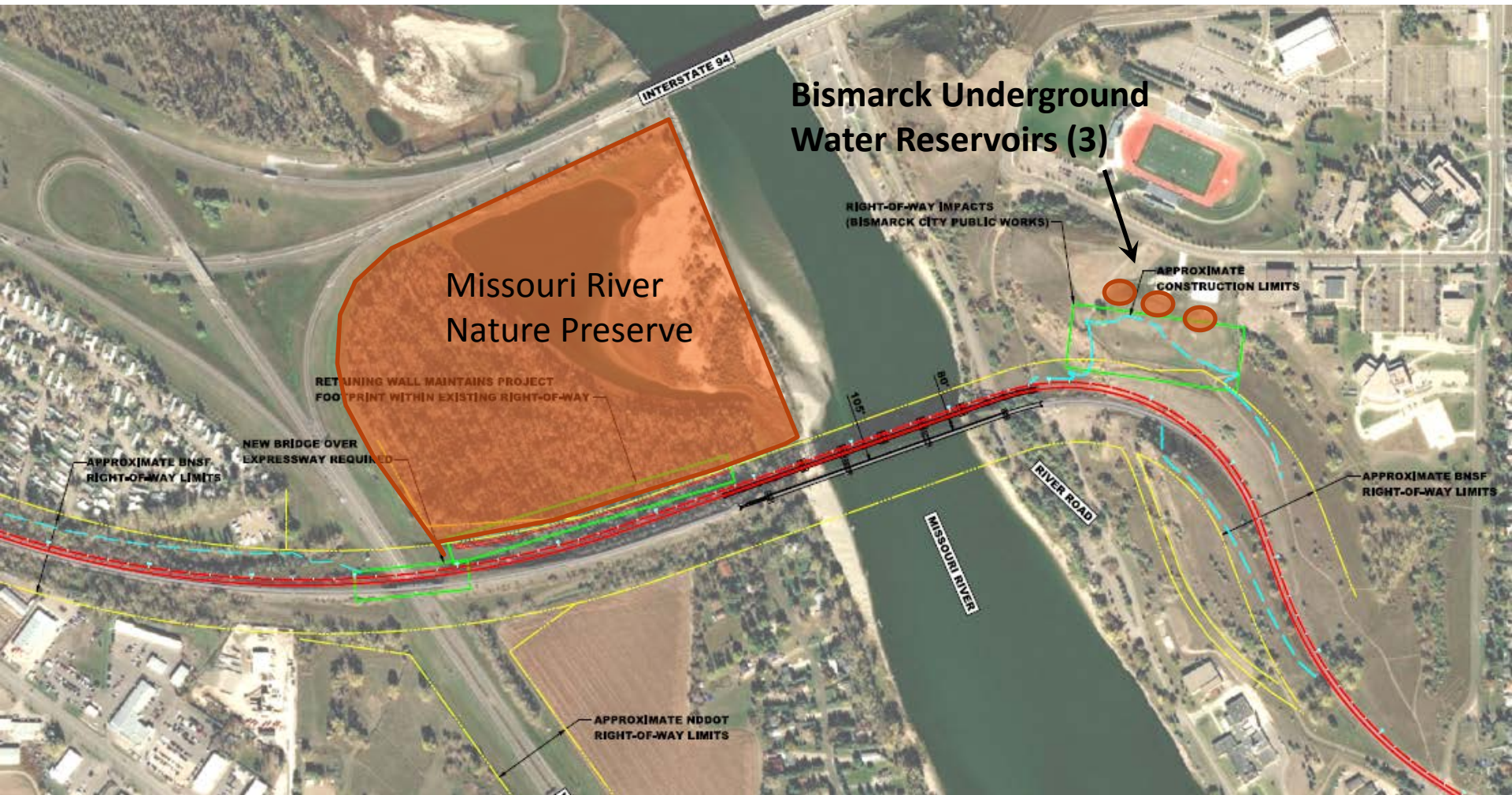

Concept 2: Efficiency Reduction

Concept 4 BNSF Preferred Design

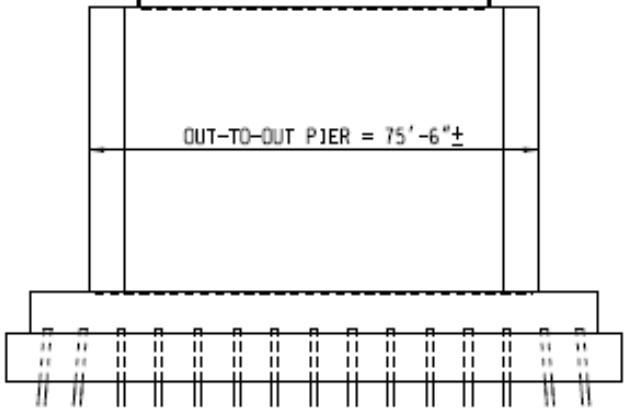
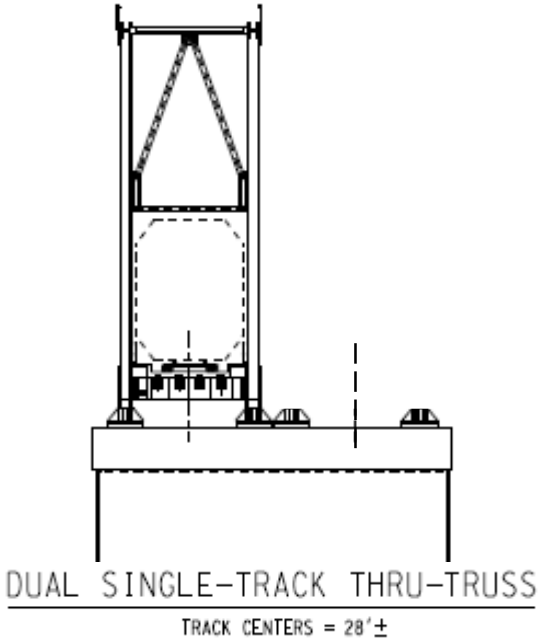
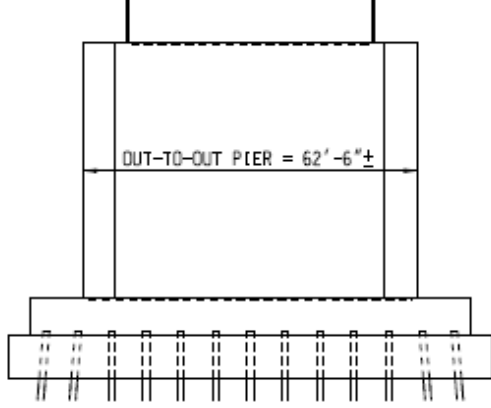
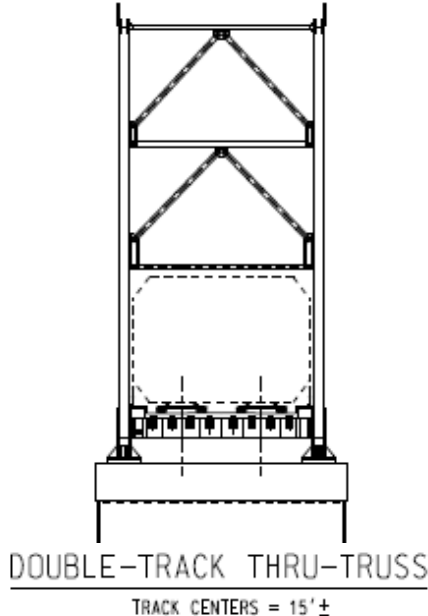
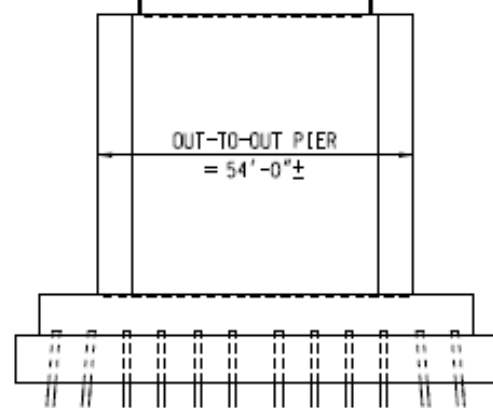
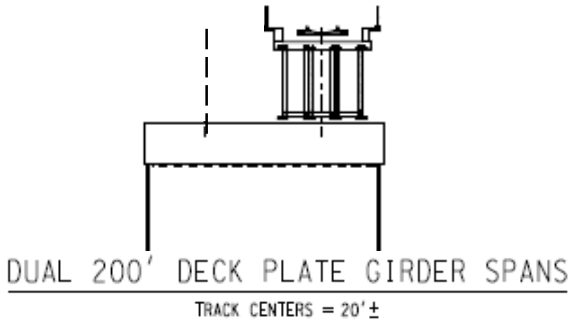

Differences Between Bismarck, ND and Sibley, MO

Why 400ft spans work at Sibley, MO?

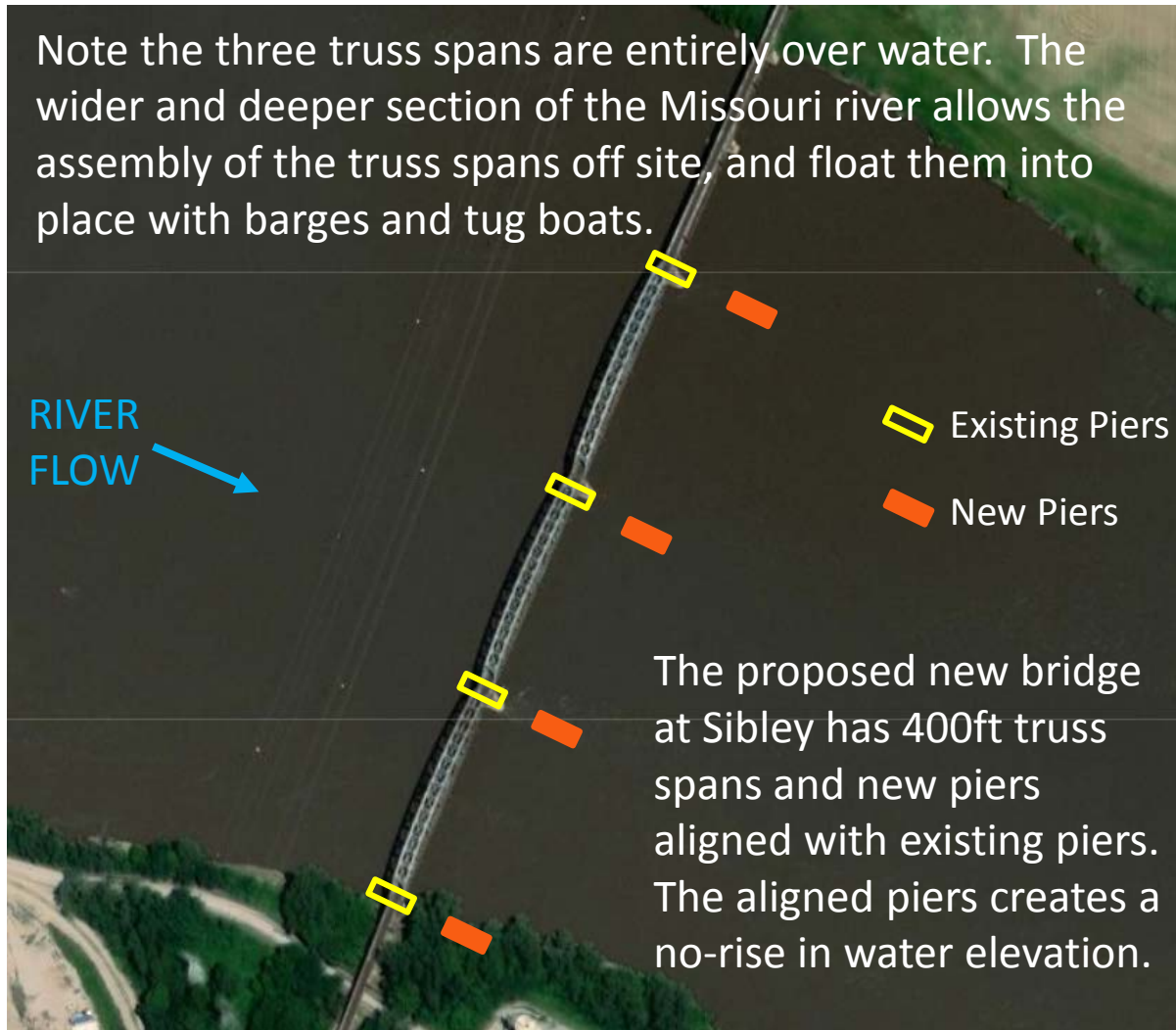

Why not use 400ft spans at Bismarck?

Note that while the center span is entirely over water, the east and west spans have approx. one-third of the span over land. This will require the use of falsework to erect the truss in place.



Truss Erection Falsework in 1905

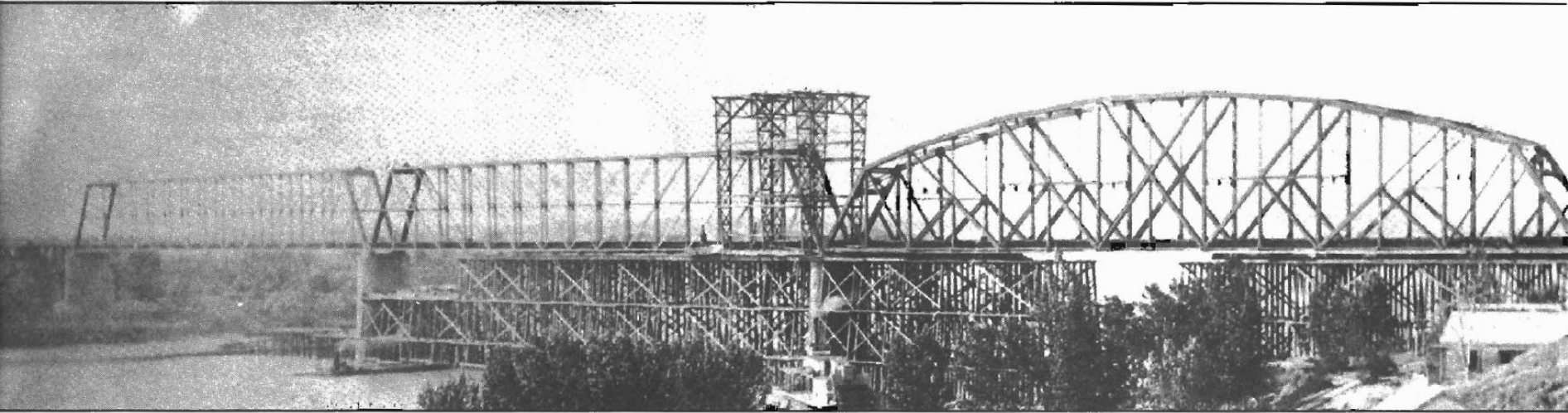

Above: The bridge spans were replaced April-December 1905. Here, the east span had been replaced and work was just beginning on replacement of the middle span. Sufficient room was left between the cribbing for steamships to pass beneath the bridge during construction. In the fall, however, shifting sandbars plugged the opening under the east side of the bridge, and the railroad had to remove the cribbing from another area to enable navigation to continue. Below: Workers driving spikes while laying track on the newly replaced east end approach span of the Northern Pacific Bridge. The base of the new east truss (replaced in September 1905) is visible in the background. The small track to the left was built to guide the construction derrick. Photo taken between November 22, 1905, and January 15, 1906. Courtesy of the Northern Pacific Railway Company Records, Minnesota Historical Society, St. Paul, Minnesota.

Concept 3:

200ft Spans, Piers 42.5ft Upstream

Concept 3: 200ft Spans, Piers 42.5ft Upstream



Concept 3: 200ft Spans, Piers 42.5ft Upstream

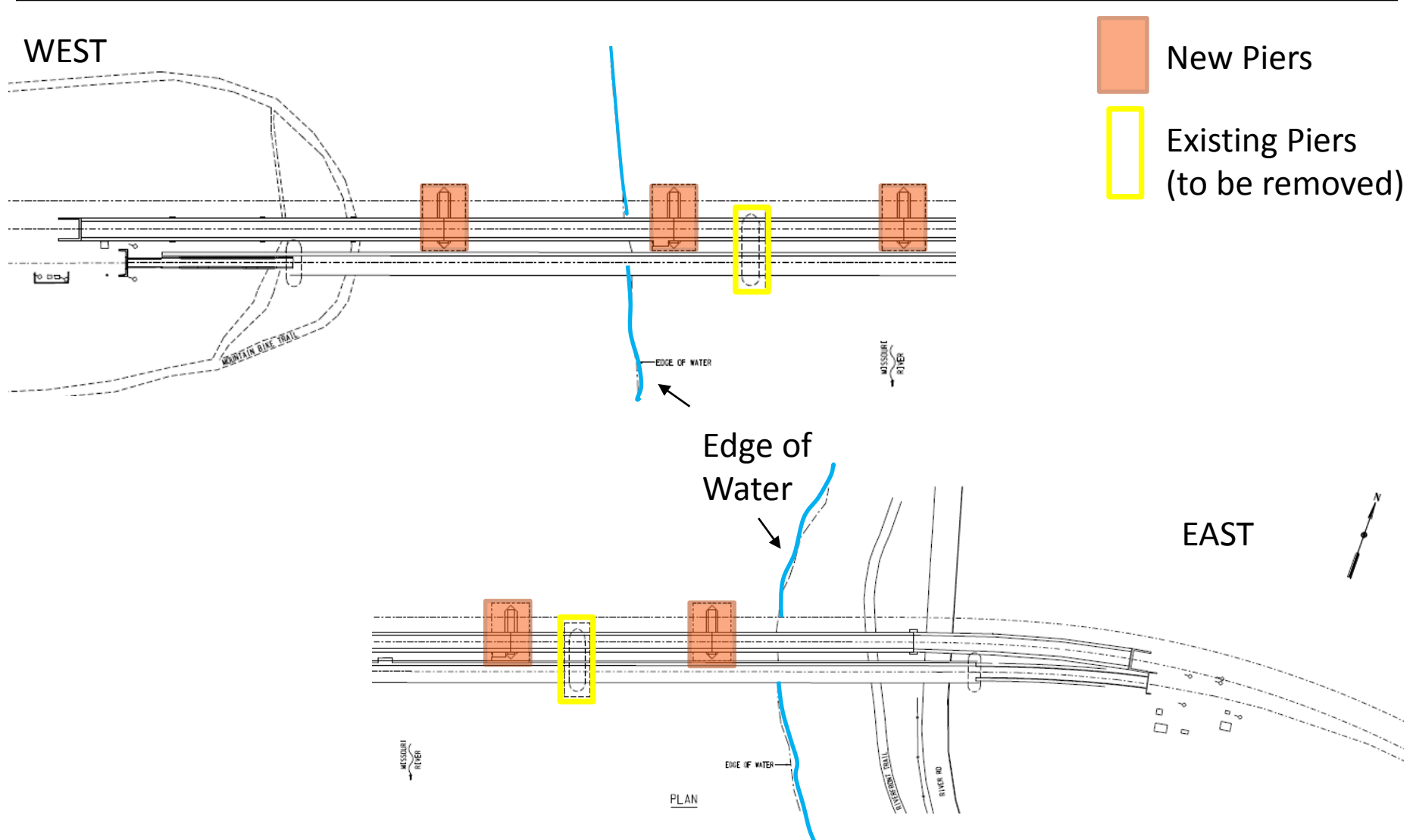

Concept 3: 200ft Spans, Piers 42.5ft Upstream

1. Environmental Impacts

1. Keeping the existing bridge, creates a rise in water elevation.
2. Remove the existing bridge, yields a no-rise in water elevation.

2. Impacts on Public

1. Construction limits extend beyond RW line.
2. Encroach on Bismarck water supply reservoirs.
3. Track geometry drives need to possibly replace rail bridge over I-194.

3. Cost and Schedule

1. Increase in cost and duration of schedule; approx. \$10M-\$15M and add one to two years.

4. Efficiency

1. Able to construct piers to accept two tracks. One track now and a future second track.

Concept 3: 200ft Spans, Piers 42.5ft Upstream

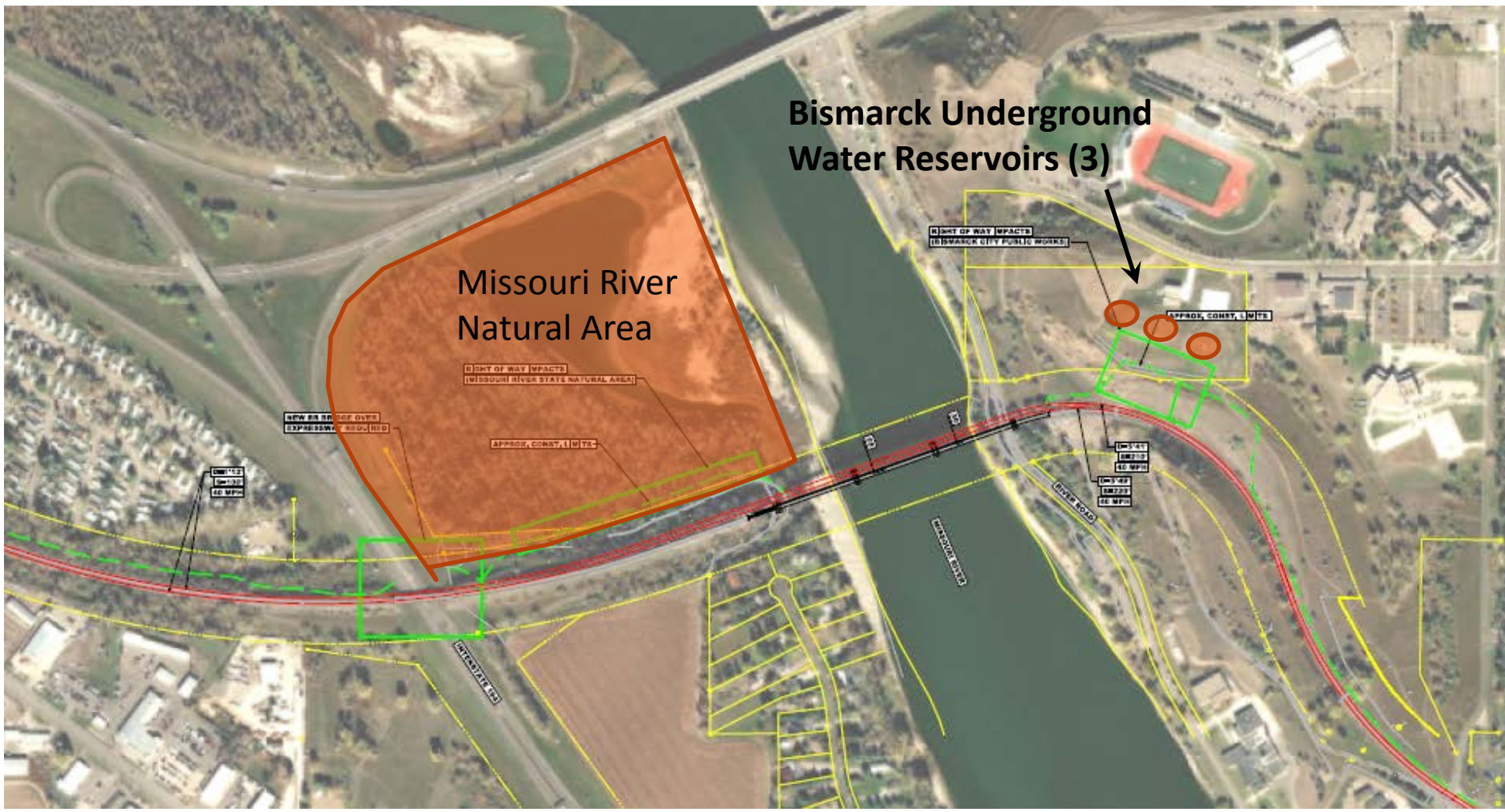

Concept 4: BNSF Preferred Design

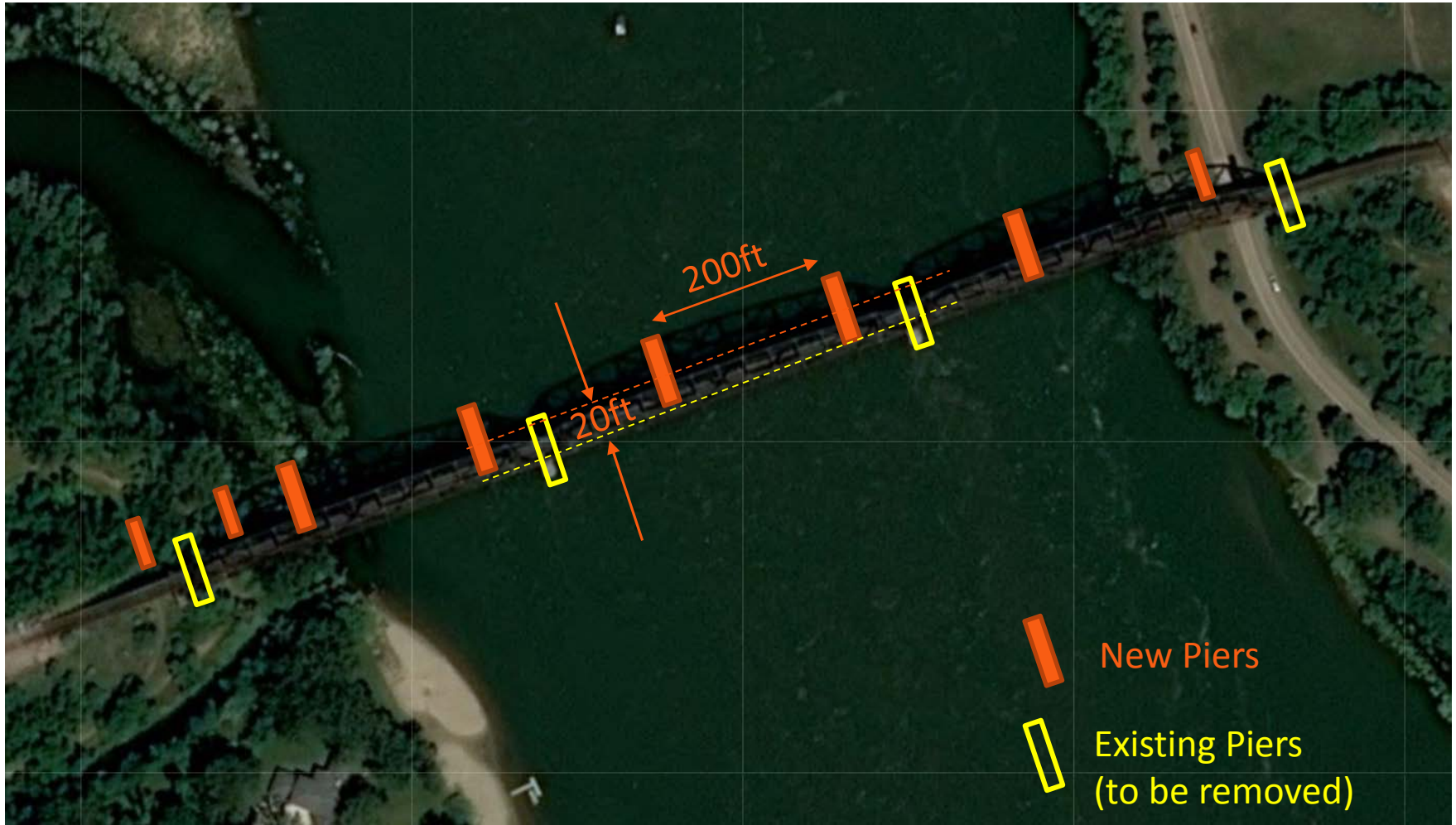

200ft Spans, Piers 20ft Upstream

Concept 4: 200ft Spans, Piers 20ft Upstream

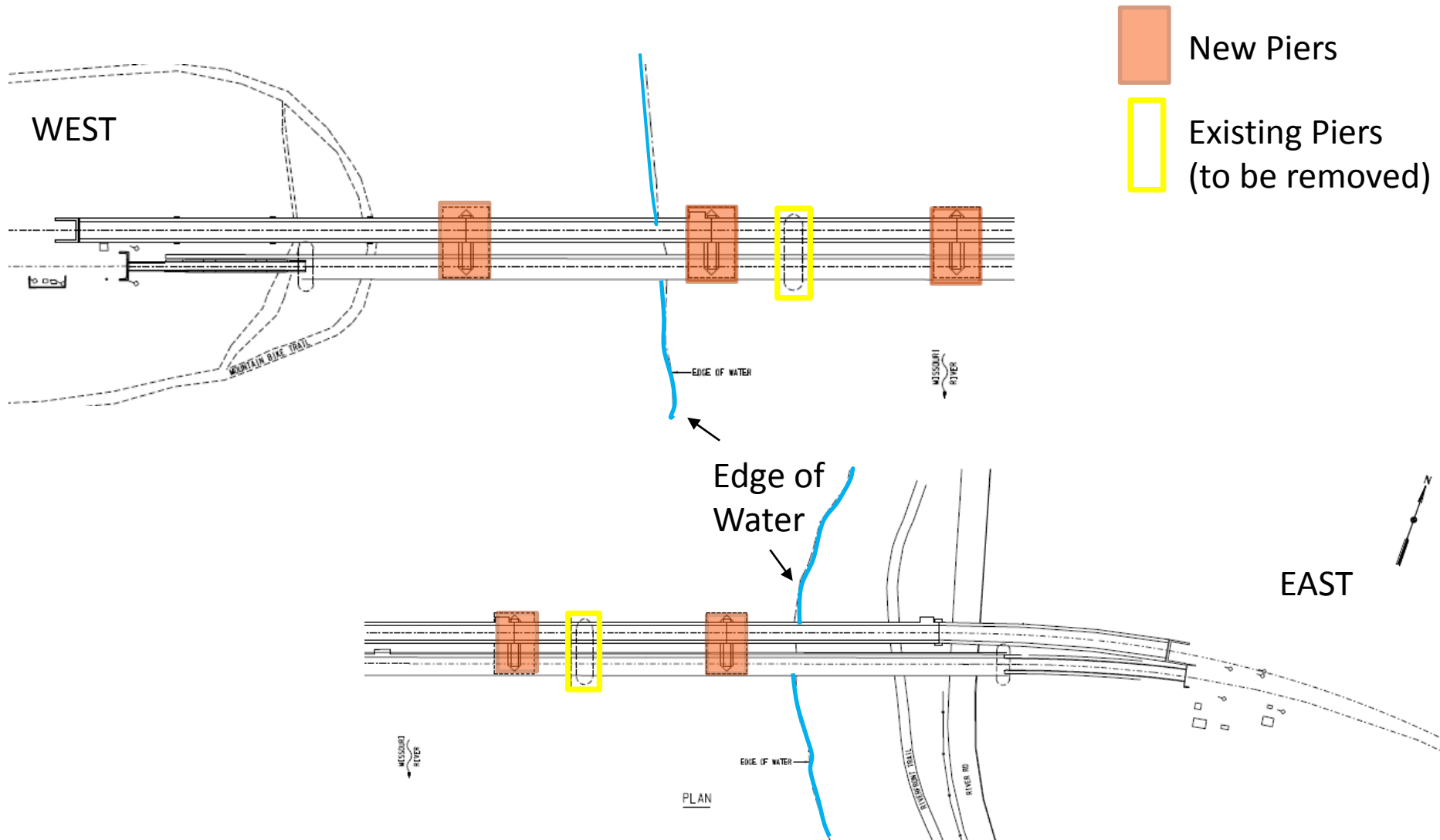

Concept 4: 200ft Spans, Piers 20ft Upstream

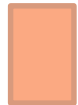

-  New Piers
-  Existing Piers (to be removed)

Concept 4: 200ft Spans, Piers 20ft Upstream

Existing bridge and track to be removed after in servicing the new bridge

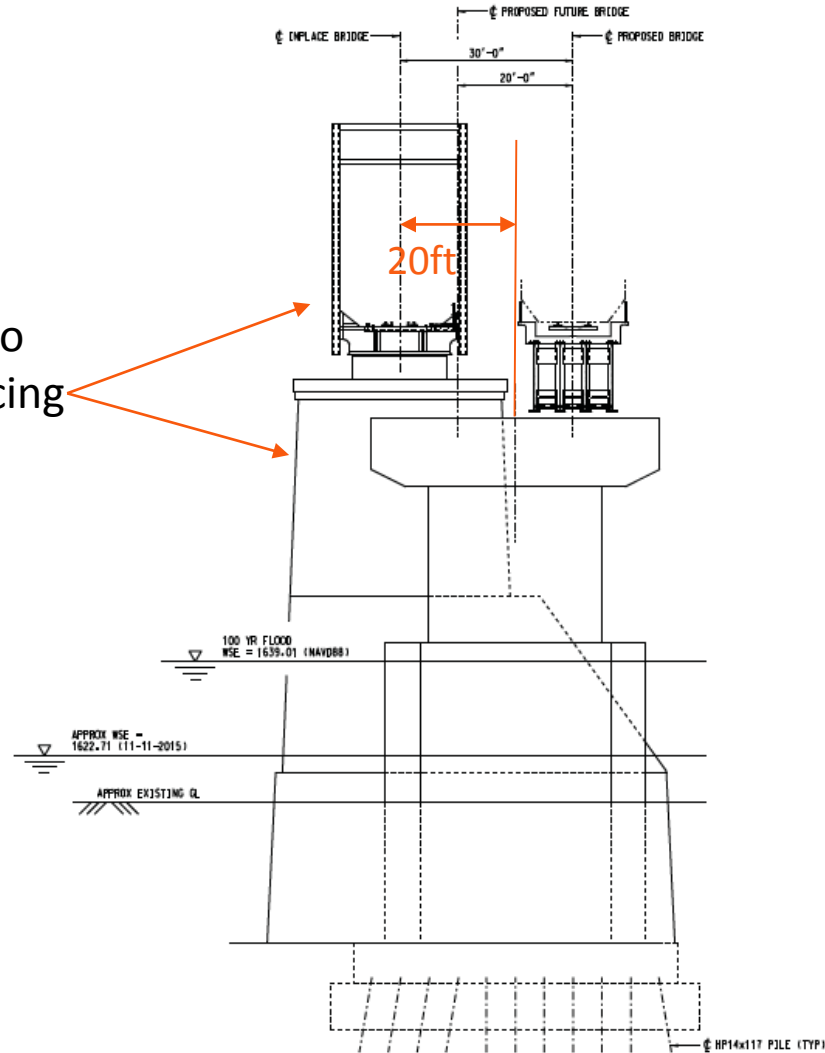

Concept 4: 200ft Spans, Piers 20ft Upstream

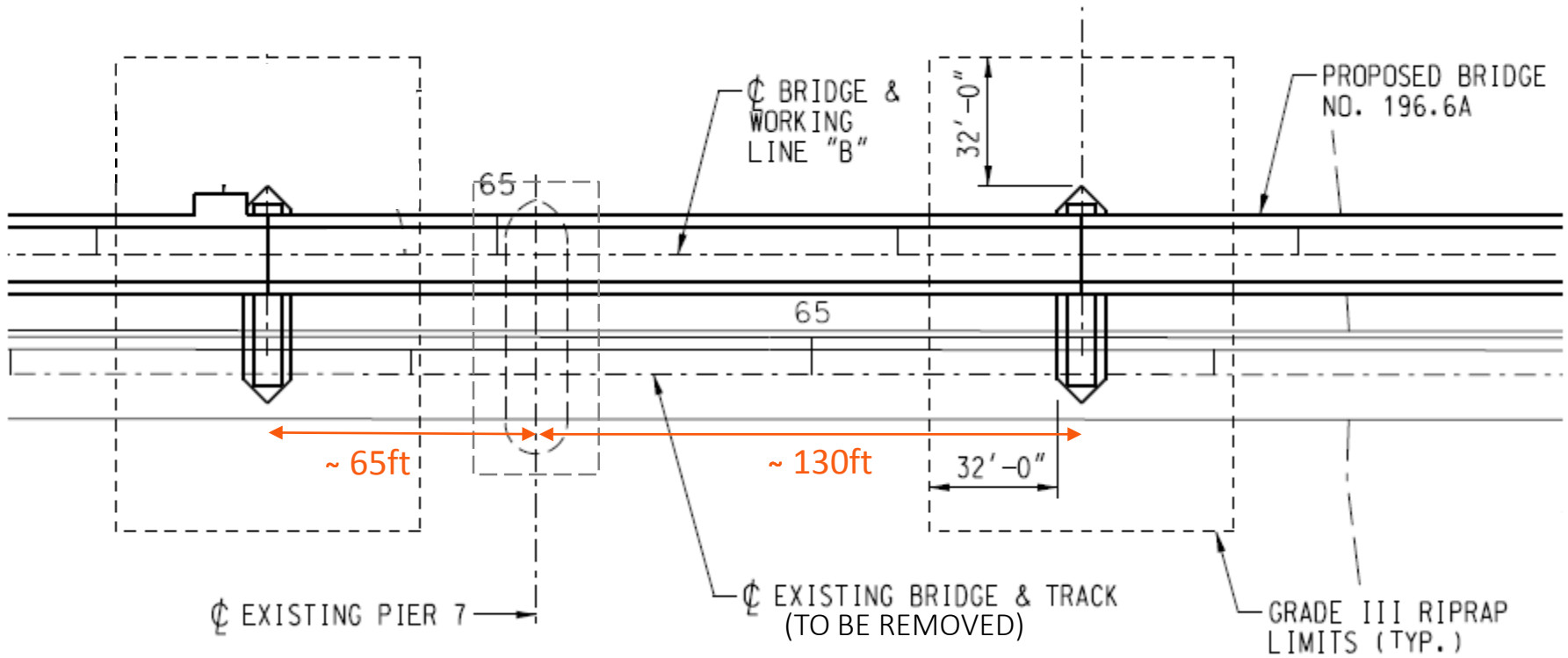

Concept 4: BNSF Preferred Design 200ft Spans, Piers 20ft Upstream

1. Environmental Impacts

1. Keeping the existing bridge, creates a rise in water elevation.
2. Remove the existing bridge, yields a no-rise in water elevation.

2. Impacts on Public

1. Construction limits remain within RW line.
2. No encroachment on Bismarck water supply reservoirs.
3. No modifications to rail bridge over I-194.

3. Cost and Schedule

1. Baseline design concept to replace bridge (\$50M-\$60M.)

4. Efficiency

1. Able to construct piers to accept two tracks. One track now and a future second track.

Design Concept Comparison

EVALUATION CRITERIA	Concept 1: 200ft Spans Piers @ 92.5ft	Concept 2: 400ft Spans Piers @ 92.5ft	Concept 3: 200ft Spans Piers @ 42.5ft	Concept: 4 200ft Spans Piers @ 20ft
No rise in water elevation with... Keeping existing bridge: Removing existing bridge:	No Yes	Yes* Yes	No Yes	No Yes
Avoids significant falsework	Yes	No	Yes	Yes
Construction limits within R/W	No	No	No	Yes
Avoids Bismarck water reservoirs	No	No	No	Yes
Use existing rail bridge over I-194	No	No	Possibly	Yes
Added Cost and schedule time (Baseline project cost)	+\$25-\$30M +2-3 years	+\$70-75M +2-4 years	+\$10-\$15M +1-2 years	Baseline @ (\$50M-\$60M)
Efficient future expansion	Yes	No	Yes	Yes

* - Hydraulic modeling not performed; intuitively expect no rise with aligned piers.

The End

Questions?